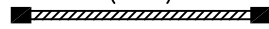
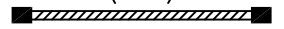

Automne	Hiver	Automne	Hiver	Automne
---------	-------	---------	-------	---------

COURS OBLIGATOIRES (9 cr.)

CF110 (3-0-6) 3 cr.

 Introd. preuve numérique

CF100 (3-0-6) 3 cr.

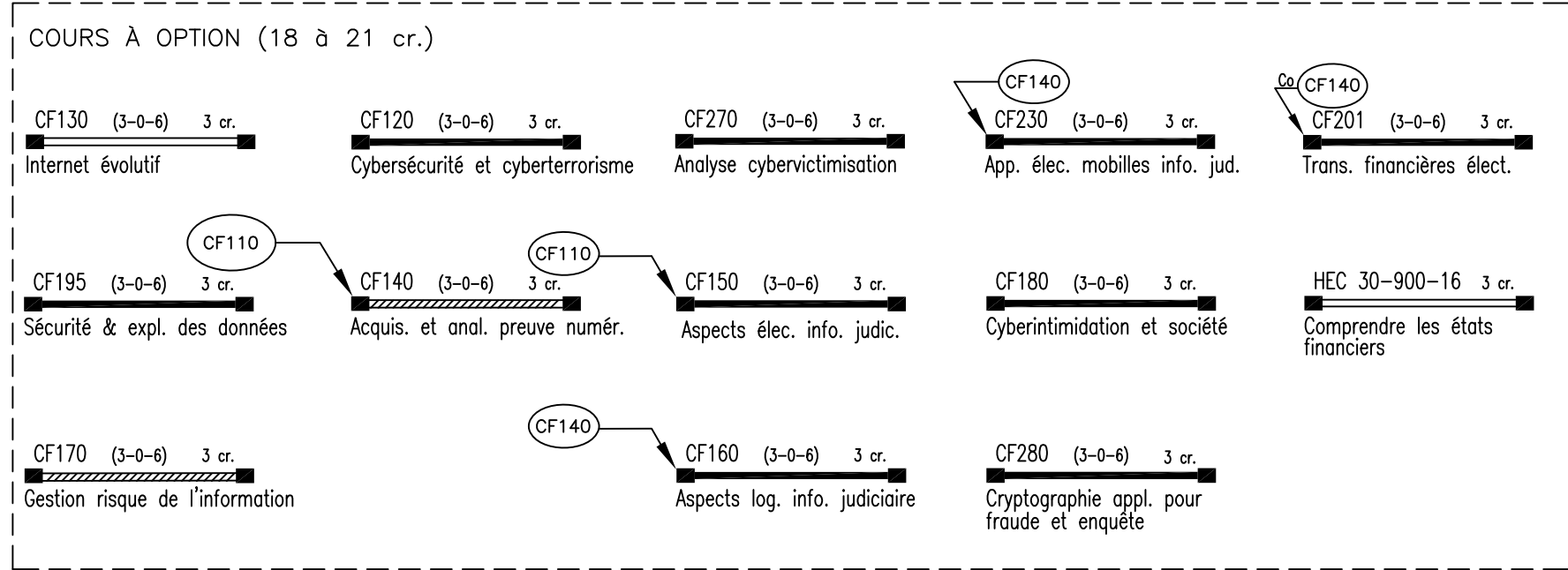
 Cyberfraude

CF210 (3-0-6) 3 cr.

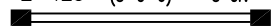
 Explor. données financières

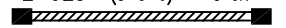

COURS AU CHOIX (0 à 3 cr.)

Z-425 (3-0-6) 3 cr.

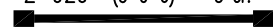
 Intro. info et prog. proc.

Z-925 (3-0-6) 3 cr.

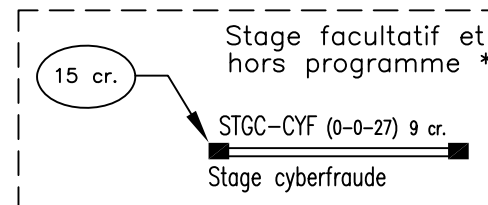
 Comm. tech. et intercult.

Z-920 (3-0-6) 3 cr.

 Trav. équipe et leadership



* Les 9 crédits de stage ne sont pas comptabilisés pour l'obtention du certificat.